



INDUSTRIAL TANK WASHING SYSTEMS

CTG LS20 BR



INTRODUCTION

INDEX

Page

| | | | |
|---|----------------|----|--|
| Tank washing techniques | | 1 | |
| Fixed spray heads | | 3 | |
| Single axis heads | Reaction drive | 7 | |
| | Motor drive | 14 | |
| Twin axis heads | Positive drive | 15 | |
| | High pressure | 19 | |
| Cleaning validation instruments | | 20 | |
| Auxiliary equipment for washing processes | | 21 | |
| Technical information | | 25 | |
| General information | | 26 | |

TECHNICAL PUBLICATIONS

PNR manufactures a complete range of spray nozzles for industrial applications, as well as products and systems specially designed for specific industries. Information about our Company and our product range is available through the following publications

| | |
|--|--------|
| PRODUCT RANGE | CTG TV |
| GENERAL PURPOSE SPRAY NOZZLES | CTG UG |
| AIR ASSISTED ATOMIZERS | CTG AZ |
| COMPLEMENTARY PRODUCTS AND ASSEMBLY FITTINGS | CTG AC |
| INDUSTRIAL TANK WASHING SYSTEMS | CTG LS |
| EVAPORATIVE COOLING LANCES | CTG LN |
| FIRE FIGHTING PRODUCTS | CTG FF |
| PAPERMILL PRODUCTS | CTG PM |
| STEELWORK NOZZLES | CTG SW |
| SPRAYDRY NOZZLES | CTG SP |

As a result of continuous product improvement, our documentation is regularly updated and mailed to Customers whose name and address are registered on our Catalogue Mailing List. We shall gladly register your name, if you mail to the nearest PNR office or Distributor the form on page 29.

NOTES

Our products and their performances are continuously reconsidered and modified to keep up with the latest state of technology.

We regret not to be able to give our Customers previous advice about these modifications: data and product specifications given in this catalogue are always to be understood as indicative, and do not firmly engage our Company.

Should your application imperatively require one or more characteristics of one of our products, as given by this Catalogue, to be strictly adhered to, we ask you to obtain a written confirmation before ordering.

All information contained into this catalogue, including product data, product codes, diagrams and photographs are the exclusive property of Flowtech Srl.

Dimensions in this catalogue are given in millimeters (mm).

All threads manufactured according to the ISO 228 standards except where indicated. (European norms BS 2779 - DIN 259 - UNI 338).

Explanations about the abbreviations used in the catalogue and warranty conditions are given at page 25.

All Trademarks mentioned in this Catalogue are the property of their respective owners.



Our Company has qualified its Quality Management System according to the ISO 9001/2000 Norms.

DNV
Cert. 04111-99-AQ
MIL SINCERT

TANK WASHING TECHNIQUES

The continuous research for higher efficiency in all kind of industries, and the requirement to assure a constant and higher quality level for their products, highlight the necessity that every step in the production, stocking and transporting processes are performed using adequately clean systems and tanks.

At the same time, as disposing of liquid effluents is becoming more and more costly, it becomes necessary that each cleaning process, while reaching a totally satisfactory result, is performed using the lowest possible volume of cleaning solution.

The two above factors have originated the introduction on the market of an always wider variety of tank cleaning devices, ranging from the classic fixed head to more and more sophisticated models to cope with the most demanding applications.

Our long experience in the field of tank cleaning suggests that the following basic concepts are given proper consideration in order to determine the correct washing cycle for each single application, and consequently the most suitable type of tank cleaning device.

1 PROPER FILTERING FOR THE WASHING LIQUID

Small inner passages and precision machined parts are typically found in tank washing equipment.

In such cases where the washing cycle is performed by means of a recycled solution the solid particles which may be dispersed into the solution must be characterized for dimension and properties.

Since suspended solid particles may affect proper operation of tank washing equipment, or require more frequent cleaning or service of the same, we suggest that a suitable line filter be considered.

See our Accessories Catalogue for a proper choice.

2 CORRECT CHOICE FOR WASHING CYCLE AND SOLUTION

Based on the type of product which has to be eliminated, each single process has to be examined in order to define such parameters as the appropriate washing fluid, the right temperature, jet pressure and washing time.

3 ADEQUATE MOTIVE MECHANISM

The number of products which need to be removed from the wall of a tank is near to endless, each one showing its own different properties.

Washing cycles can range from a quick water rinse at low pressure and ambient temperature, to long lasting cycles using hot water and caustic, sometimes at high pressure.

The latter situation requires both a slow motion of the fluid jets, which have to hit the tank wall without breaking into drops and loose their impact, and a properly indexed rotation so that the revolving jets do not hit the same path at each turn.

Our tankwashers range, the most complete on the market, is classified by number of rotation axis and type of motive mechanism.

4 CLEANING RADIUS / WETTING RADIUS

It is not possible to define the cleaning radius of any tank washing equipment without making reference to precise conditions as the product to be eliminated, the cleaning fluid, the operating pressure and temperature.

Such value can only be determined by experience, for each single given process.

It is instead possible to define a wetting radius, as the radius where the equipment can wet the entire tank inner surface: in this condition it must be expected the fluid to hit the wall with a small fraction of its original impact force.

The value for wetting radius (GM) is given for any of our tankwashers at a pressure value of 2.0 bar, in the general information table at page 25.

Since the design of our products is continuously updated, please consider this information as an orientation value only, and ask for a test report from our laboratories to obtain data relating to our latest design.

INTRODUCTION

TANK WASHING TECHNIQUES

CONSTRUCTION MATERIALS

Because of their application in the chemical, food and pharmaceutical processes tankwashers are manufactured as a rule out of high quality materials, offering in various combinations high resistance to corrosion and ability to withstand high temperatures.

Metal parts are usually made of austenitic stainless steel, mostly AISI 316, AISI 316L and AISI 316Ti grades, while some special applications may require high grade alloys like Hastelloy, in a variety of types.

Parts in plastic materials are normally made out Teflon, Carbon filled Teflon or PEEK.

EFFICIENCY ASSESSMENT

It is very difficult to assess such value as the efficiency range with reference to a given tank washing device without taking into considerations the various parameters relating to the process conditions.

Data on wetting radius for each tankwasher are given at the end of this catalogue.

In addition to this basic information we are designing instrumentation capable of determining more precise values under different conditions: please ask our Engineering Office for additional information.

CLEANING VALIDATION

This is the process whereby the desired cleaning condition is verified by means of a repeatable technique supplying results easily readable and according to the quality control requirements. Prior to any cleaning validation process it is generally good practice to validate coverage, that is to insure that all surface that requires cleaning receives the minimal washing solution requirement.

This is properly performed by a Riboflavin test, spraying Riboflavin onto the surface, and then performing the prescribed washing cycle.

Riboflavin is easily miscible with water at ambient temperature, and should be completely eliminated from the surface when the same is satisfactorily covered by the washing jets.

Traces of Riboflavine still sticking to the surface are revealed through an ultra-violet long wave light, and indicate areas not properly covered from the washing operation.

Once sufficient rinse is established, the most convenient way for cleaning validation is using an ATP conductivity test by means of properly designed instrumentation. See page 20.

PROCESS DATA

In addition to the efficiency parameters introduced above we have also started gathering information on each single process and will be able to make them available to our Customers in short.

Please contact our Engineering Office on this matter.

DEFINITIONS

Spray pattern angle

It is always understood as the solid angle with an origin in the point of the tankwasher opposite to the water inlet, normally at the center of the rotating part.

The jet direction is defined as in the following:

- The inlet feed pipe is on the upper end of the tank.
- The spray direction is 'down' if the jet goes to tank bottom.

For a tankwasher on the top of tank a spray angle of 180° means the lower half of the tank is washed.

For a tankwasher on the bottom of tank a spray angle of 270° means the upper part of the tank is washed, leaving the lower part of the tank for a solid angle of 90° not covered.

Fixed spray balls have a special spray coverage definition at page 4.

Single axis tankwasher

It's a device where the moving part is rotating around the vertical axis of the feed pipe.

Twin axis tankwasher

It's a device where the washing nozzles rotate around an horizontal axis, while the tankwasher body carrying the nozzles rotates around the vertical axis of the feed pipe.

WASHING EQUIPMENT TYPES

FIXED SPRAY HEADS

The most simple tank washing devices, fixed heads or spray balls are the classic equipment used in thousands of tanks for their reliability and since easily kept in perfect hygienic conditions.

Their low impact properties and high volume fluid requirement limit their use to small tank sizes and processes where easily cleaned liquids and non sticking products have to be eliminated.

Our models UAA, UAB and UAC are made out of high quality stainless steel and cover most possible applications, while we are still pleased to quote for special models designed on individual requirements.



FIXED HEADS CODING SYSTEM

With regard to our fixed heads range we have organized the following coding system:

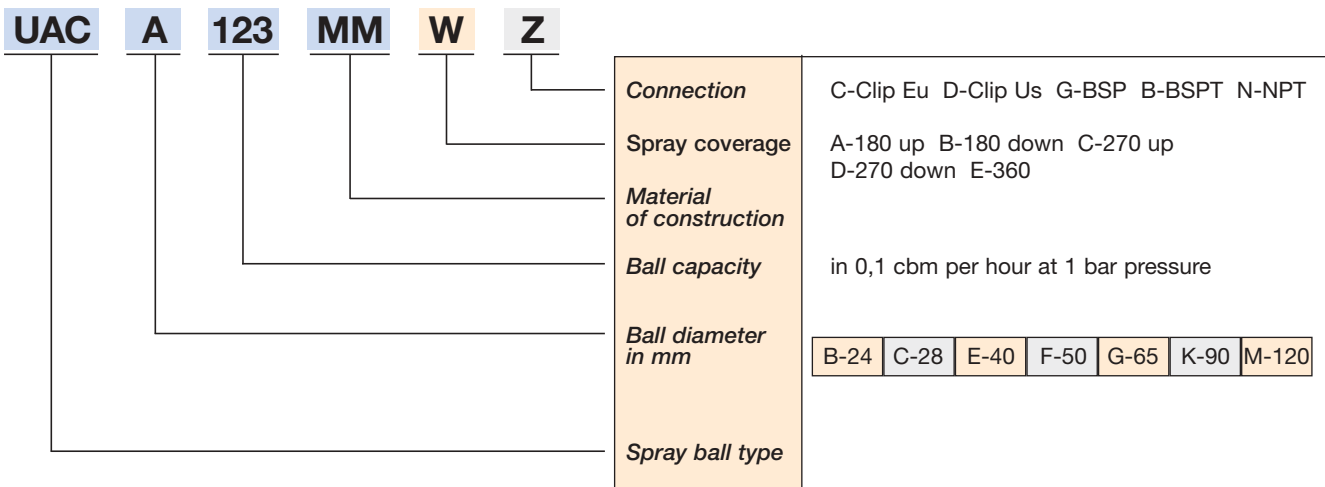

CLIP PIPE SIZES

Most fixed spray balls are retained in place by means of a clip connection which assures ease of disassembling plus fast and perfect cleaning.

Unfortunately the pipe sizes are not equal over all different trades and national markets, therefore we offer different sizes for our balls, as follows

UAA series have clip sizes as shown in the capacity tables, where inner and outer pipe diameter are specified.

UAC series have normalized sizes based on pipe DN size as shown in the diagram beside the capacity table.

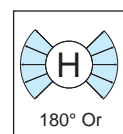
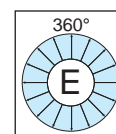
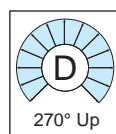
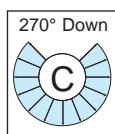
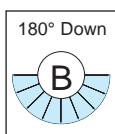
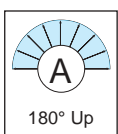

TANK WASHING EQUIPMENT

FIXED HEADS

UAA

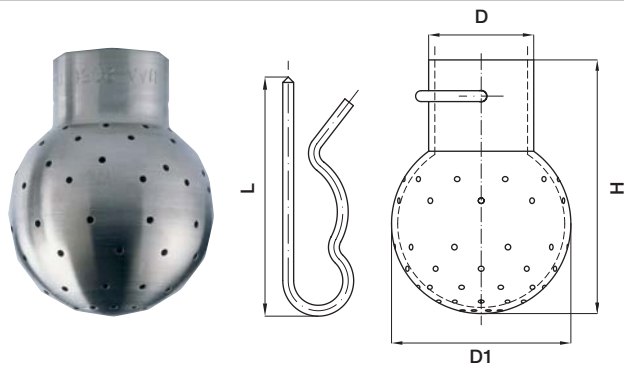

UAA fixed spray heads are a simple, fast and efficient device for cleaning the inside of small size tanks where a simple rinsing action is required.

Their simple design allows for the head to be easily cleaned after being operated, which makes it possible to leave the heads permanently in place ready for use.

Because of the relatively high washing fluid flow rate, they are usually operated at low pressures and can achieve a limited impact action on the tank wall.

However, in those cases where fixed heads can achieve a satisfactory cleaning result, their simple design assures low investment cost and maximum reliability.

The figures for wetting radiuses shown at the right of the table have been obtained operating the heads with a water pressure value of 1 bar.

Material B31 Aisi 316L Stainless steel
Connection Female BSP thread
 Pipe clip

Female BSP connection

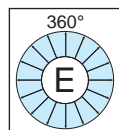
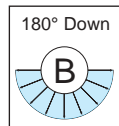
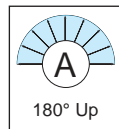

| Code | D inch | D1 mm | Capacity at different pressures | | | | H mm | WR m |
|----------------|-----------|----------|---------------------------------------|------|------|------|---------|---------|
| | | | 1.0 | 1.5 | 2.0 | 2.5 | | |
| UAA C012 B31AG | 1/4 | 28 | 1.20 | 1.46 | 1.69 | 1.89 | 34 | 1.6 |
| UAA C014 B31BG | | 28 | 1.40 | 1.71 | 1.98 | 2.21 | 34 | 2.2 |
| UAA C018 B31EG | | 28 | 1.80 | 2.20 | 2.54 | 2.84 | 34 | 1.0 |
| UAA F030 B31AG | 1/2 | 50 | 3.00 | 3.68 | 4.25 | 4.75 | 60 | 3.0 |
| UAA F034 B31BG | | 50 | 3.10 | 3.80 | 4.38 | 4.90 | 60 | 3.2 |
| UAA F054 B31EG | | 50 | 5.40 | 6.61 | 7.63 | 8.54 | 60 | 2.4 |
| UAA G087 B31AG | 3/4 | 65 | 8.70 | 10.6 | 12.3 | 13.7 | 78 | 2.2 |
| UAA G092 B31BG | | 65 | 9.20 | 11.3 | 13.0 | 14.5 | 78 | 2.5 |
| UAA G132 B31EG | | 65 | 13.2 | 16.1 | 18.6 | 20.8 | 78 | 1.3 |
| UAA K127 B31AG | 1 1/4 | 90 | 12.7 | 15.6 | 17.9 | 20.0 | 106 | 2.2 |
| UAA K159 B31BG | | 90 | 15.9 | 19.5 | 22.5 | 25.1 | 106 | 3.4 |
| UAA K298 B31EG | | 90 | 29.8 | 36.5 | 42.1 | 47.1 | 106 | 3.1 |

PRODUCT CODE

The codes in the table beside refer to heads with different spray patterns, BSP female threads as shown in the table.

Please note the product code differences according to the spray patterns, as indicated in the diagrams beside.

(NPT thread types shown in our American Catalog CTG LS).

Please note the digit before the last one in the code shows the head spray pattern as indicated in the diagrams.

TANK WASHING EQUIPMENT

Product Code

FIXED HEADS

The codes in the table below refer to heads with different spray patterns and different clip connections. While the connection pipe of each head has the dimensions shown in the table, please note the product code differences according to the spray patterns, as indicated in the diagrams below. All our UAA heads have a flat upper side to assure cleaning action over the area around the inlet pipe.

Clip-on connection

| Code | D mm | D1 mm | Capacity at different pressures | | | | m ³ /h bar | H mm | WR m |
|------|------|-------|---------------------------------|-----|-----|-----|-----------------------|------|------|
| | | | 1.0 | 1.5 | 2.0 | 2.5 | | | |

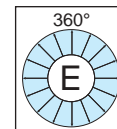
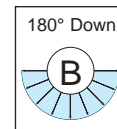
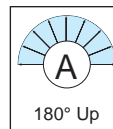

| | | | | | | | | |
|----------------|-------------|-----|------|------|------|------|-----|-----|
| UAA C012 B31AC | 22.0 x 20.0 | 28 | 1.20 | 1.46 | 1.69 | 1.89 | 34 | 1.4 |
| UAA E023 B31AC | | 40 | 2.30 | 2.82 | 3.25 | 3.64 | 62 | 5.5 |
| UAA E030 B31AC | | 40 | 3.00 | 3.68 | 4.25 | 4.75 | 62 | 3.0 |
| UAA F034 B31AC | | 50 | 3.40 | 4.16 | 4.81 | 5.38 | 74 | 3.0 |
| UAA F047 B31AD | 28.0 x 26.0 | 50 | 4.70 | 5.76 | 6.65 | 7.43 | 76 | 7.2 |
| UAA G053 B31AD | | 65 | 5.30 | 6.49 | 7.50 | 8.38 | 92 | 2.5 |
| UAA G093 B31AE | 32.0 x 30.0 | 65 | 9.30 | 11.4 | 13.1 | 14.7 | 92 | 2.5 |
| UAA K134 B31AH | 38.0 x 36.0 | 90 | 13.4 | 16.4 | 18.9 | 21.2 | 118 | 2.4 |
| UAA M102 B31AL | 60.3 x 52.8 | 120 | 10.2 | 12.5 | 14.4 | 16.1 | 150 | 2.3 |

| | | | | | | | | |
|----------------|-------------|-----|------|------|------|------|-----|-----|
| UAA C014 B31BC | 22.0 x 20.0 | 28 | 1.40 | 1.71 | 1.98 | 2.21 | 34 | 1.2 |
| UAA E023 B31BC | | 40 | 2.30 | 2.82 | 3.25 | 3.64 | 62 | 5.9 |
| UAA E031 B31BC | | 40 | 3.10 | 3.80 | 4.38 | 4.90 | 62 | 3.1 |
| UAA F032 B31BC | | 50 | 3.20 | 3.92 | 4.53 | 5.06 | 74 | 3.2 |
| UAA F047 B31BD | 28.0 x 26.0 | 50 | 4.70 | 5.76 | 6.65 | 7.43 | 76 | 7.2 |
| UAA G055 B31BD | | 65 | 5.55 | 6.74 | 7.78 | 8.70 | 92 | 3.2 |
| UAA G105 B31BE | 32.0 x 30.0 | 65 | 10.5 | 12.9 | 14.9 | 16.6 | 92 | 3.2 |
| UAA K159 B31BH | 38.0 x 36.0 | 90 | 15.9 | 19.5 | 22.5 | 25.1 | 118 | 3.4 |
| UAA M089 B31BL | 60.3 x 52.8 | 120 | 8.90 | 10.9 | 12.6 | 14.1 | 150 | 1.7 |

| | | | | | | | | |
|----------------|-------------|-----|------|------|------|------|-----|-----|
| UAA C018 B31EC | 22.0 x 20.0 | 28 | 1.80 | 2.20 | 2.54 | 2.84 | 34 | 1.8 |
| UAA E038 B31EC | | 40 | 3.80 | 4.65 | 5.37 | 6.01 | 62 | 3.8 |
| UAA E051 B31EC | | 40 | 5.10 | 6.25 | 7.21 | 8.06 | 62 | 2.4 |
| UAA F055 B31EC | | 50 | 5.55 | 6.74 | 7.78 | 8.70 | 74 | 2.4 |
| UAA F072 B31ED | 28.0 x 26.0 | 50 | 7.20 | 8.82 | 10.2 | 11.4 | 76 | 4.3 |
| UAA G086 B31ED | | 65 | 8.60 | 10.5 | 12.2 | 13.6 | 92 | 2.3 |
| UAA G179 B31EE | 32.0 x 30.0 | 65 | 17.9 | 21.9 | 25.3 | 28.3 | 92 | 2.3 |
| UAA K242 B31EH | 38.0 x 36.0 | 90 | 24.2 | 29.6 | 34.2 | 38.2 | 118 | 2.0 |
| UAA M190 B31EL | 60.3 x 52.8 | 120 | 19.0 | 23.3 | 26.8 | 30.0 | 150 | 2.0 |

UAB

UAB heads are very compact devices, for applications like pipe washing or for cleaning tight spaces. The thick walls of this device, which is machined from solid stainless steel rod, make it also a good choice where the washing process needs to be performed at high pressure values.

Female BSP thread

| Code | E mm | D mm | Capacity at different pressures | | | | lpm bar |
|------|------|------|---------------------------------|-----|-----|-----|---------|
| | | | 2.0 | 3.0 | 4.0 | 5.0 | |

| | | | | | | |
|---------------|-----|----|------|------|------|------|
| UAB 2220 xxSG | 0.8 | 26 | 18.0 | 22.0 | 25.3 | 28.5 |
| UAB 2343 xxSG | 1.0 | | 28.0 | 34.3 | 39.5 | 44.3 |
| UAB 2700 xxSG | 1.5 | | 57.0 | 70.0 | 80.5 | 90.3 |
| UAB 3110 xxSG | 2.0 | | 90.0 | 110 | 126 | 142 |
| UAB 3145 xxSG | 2.3 | | 118 | 145 | 167 | 187 |

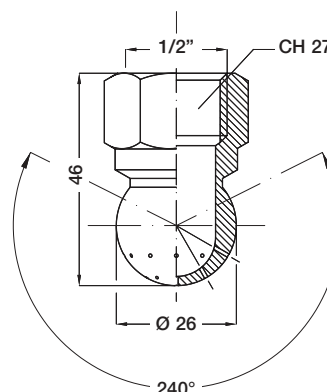

Material B1 Aisi 303 Stainless steel
B31 Aisi 316L Stainless steel

TANK WASHING EQUIPMENT

FIXED HEADS

UAC

UAC series spray balls are manufactured out of solid stainless steel bars and feature high wall thickness for maximum service life, excellent resistance to damages from impact and superior efficiency. In fact their wall thickness allows to obtain water outlet orifices with the ideal geometry to maximize the efficiency of the water jets, that is the ideal orifice length/orifice diameter ratio. This is of course not possible when the ball body is obtained from stamped steel sheet.

Material **B31** Aisi 316L Stainless steel
L8 Hastelloy C276

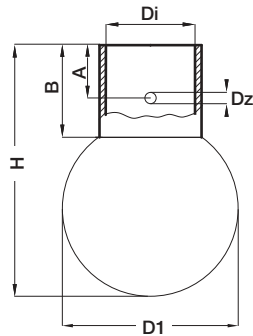

| Dn | Di | Dz | A | B | H |
|----|------|-----|----|----|-----|
| 15 | 18.2 | 2.2 | 9 | 18 | 42 |
| 20 | 22.2 | 2.5 | 9 | 21 | 53 |
| 25 | 28.3 | 2.8 | 18 | 35 | 90 |
| 32 | 34.2 | 2.8 | 18 | 35 | 90 |
| 40 | 43.3 | 2.8 | 18 | 35 | 90 |
| 50 | 52.3 | 3.3 | 25 | 48 | 122 |

Clip-on connection

| Code | Dn mm | D1 mm | Capacity at different pressures | | | | WR m |
|------|-------|-------|---------------------------------|-----|-----|-----|------|
| | | | 1.0 | 1.5 | 2.0 | 2.5 | |

180° Up

| | | | | | | | |
|----------------|----|----|------|------|------|------|-----|
| UAC D021 B31AC | 15 | 32 | 2.10 | 2.60 | 3.00 | 3.30 | 0.5 |
| UAC E056 B31AC | 20 | 40 | 5.60 | 6.80 | 7.90 | 8.80 | 1.0 |
| UAC G087 B31AC | 25 | 65 | 8.70 | 10.6 | 12.3 | 13.7 | 1.0 |
| UAC G096 B31AC | 40 | 65 | 9.60 | 11.7 | 13.6 | 15.2 | 1.5 |
| UAC G098 B31AC | 32 | 65 | 9.80 | 12.0 | 13.8 | 15.5 | 1.5 |
| UAC G142 B31AC | 25 | 65 | 14.2 | 17.4 | 20.1 | 22.4 | 1.5 |
| UAC G149 B31AC | 40 | 65 | 14.9 | 18.2 | 21.0 | 23.5 | 1.8 |
| UAC G160 B31AC | 32 | 65 | 16.0 | 19.6 | 22.6 | 25.3 | 1.8 |
| UAC K195 B31AC | 50 | 90 | 19.5 | 23.9 | 27.5 | 30.8 | 2.0 |
| UAC K310 B31AC | 50 | 90 | 31.0 | 38.0 | 43.8 | 49.0 | 2.8 |
| UAC K361 B31AC | 50 | 90 | 36.0 | 44.0 | 50.9 | 56.8 | 3.8 |

270° Up

| | | | | | | | |
|----------------|----|----|------|------|------|------|-----|
| UAC E075B31CC | 20 | 40 | 7.50 | 9.2 | 10.6 | 11.8 | 1.1 |
| UAC G100 B31CC | 25 | 65 | 10.0 | 12.2 | 14.1 | 15.8 | 1.5 |
| UAC G104 B31CC | 40 | 65 | 10.4 | 12.7 | 14.7 | 16.4 | 1.6 |
| UAC G114 B31CC | 32 | 65 | 11.4 | 13.9 | 16.1 | 18.0 | 1.5 |
| UAC G160 B31CC | 25 | 65 | 16.0 | 19.6 | 22.6 | 25.3 | 1.8 |
| UAC G180 B31CC | 40 | 65 | 18.0 | 22.0 | 25.4 | 28.4 | 1.8 |
| UAC G200 B31CC | 32 | 65 | 20.0 | 24.4 | 28.2 | 31.6 | 1.8 |
| UAC K277 B31CC | 50 | 90 | 27.7 | 33.9 | 39.1 | 43.8 | 2.0 |
| UAC K450 B31CC | 50 | 90 | 45.0 | 55.1 | 63.6 | 71.0 | 2.5 |

180° Down

| | | | | | | | |
|----------------|----|----|------|------|------|------|-----|
| UAC C025 B31BC | 15 | 32 | 2.50 | 3.10 | 3.50 | 3.90 | 0.5 |
| UAC D063 B31BC | 20 | 40 | 6.30 | 7.70 | 8.90 | 9.80 | 1.0 |
| UAC G070 B31BC | 25 | 65 | 7.00 | 8.60 | 9.90 | 11.0 | 1.3 |
| UAC G078 B31BC | 32 | 65 | 7.80 | 9.50 | 11.0 | 12.3 | 1.3 |
| UAC G109 B31BD | 40 | 65 | 10.9 | 13.3 | 15.4 | 17.2 | 1.5 |
| UAC G124 B31BD | 25 | 65 | 12.4 | 15.1 | 17.5 | 19.6 | 1.6 |
| UAC G137 B31BE | 32 | 65 | 13.7 | 16.7 | 19.3 | 21.6 | 1.6 |
| UAC G140 B31BD | 40 | 65 | 14.0 | 17.1 | 19.8 | 22.1 | 1.6 |
| UAC K170 B31BH | 50 | 90 | 17.0 | 20.8 | 24.0 | 26.8 | 2.0 |
| UAC K307 B31BL | 50 | 90 | 30.7 | 37.6 | 43.4 | 48.5 | 2.5 |

360°

| | | | | | | | |
|----------------|----|----|------|------|------|------|-----|
| UAC D042 B31EC | 15 | 32 | 4.20 | 5.10 | 5.95 | 6.60 | 0.5 |
| UAC E077 B31EC | 20 | 40 | 7.70 | 9.40 | 10.9 | 12.2 | 1.0 |
| UAC G110 B31EC | 25 | 65 | 11.0 | 13.5 | 15.6 | 17.4 | 1.0 |
| UAC G118 B31EC | 40 | 65 | 11.8 | 14.4 | 16.6 | 18.7 | 1.5 |
| UAC G135 B31EC | 32 | 65 | 13.5 | 16.5 | 19.0 | 21.3 | 1.5 |
| UAC G175 B31EC | 25 | 65 | 17.5 | 21.4 | 24.7 | 27.6 | 1.8 |
| UAC G217 B31EC | 32 | 65 | 21.7 | 26.5 | 30.7 | 34.3 | 1.5 |
| UAC G228 B31EC | 40 | 65 | 22.8 | 27.9 | 32.2 | 36.0 | 1.8 |
| UAC K286 B31EC | 50 | 90 | 28.6 | 35.0 | 40.4 | 45.2 | 2.0 |
| UAC K491 B31EC | 50 | 90 | 49.1 | 60.1 | 69.4 | 77.6 | 2.5 |

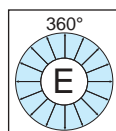
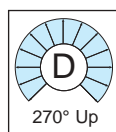
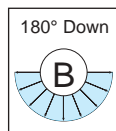
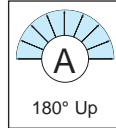

SINGLE AXIS HEADS

SINGLE AXIS HEADS / REACTION DRIVE

The washing action is obtained through water jets coming from a rotating head, where the head motion is obtained purely through reaction force originated by the fluid jets being ejected.

The operating pressure influences the head rotation speed, which must be limited to avoid the water jets being broken into minute droplets and losing part of their impact.

These devices perform very satisfactorily in a great number of general applications, where the products to be washed away do not originate severe problems and with limited size tanks.

To cope with the large variety of industrial applications we offer heads made out completely of stainless steel, out of PTFE, PVDF or a mix of those materials.

Connections are obtained through female thread or easy to clean clip fix slip-on pipe. (Page 08)



SINGLE AXIS HEADS / MOTOR DRIVE

A further step in performance with one axis heads performance is obtained with a design where a very simple friction motor provides for low speed rotating head.

This design offers a remarkable advantage because of the lower rotation velocity: the jets remain coherent without being broken into droplets by centrifugal force and all of their impact energy can be transferred to the tank surface.

(Page 13)



SPRAY ANGLES

All the spray angle values given in this catalog are to be understood for heads hanging from the tank top and spraying downwards.

Therefore the definitions of Up and Down assigned to a given spray angle of a tankwasher always refer to the same direction as the upper and lower part of the tank.

See the diagrams beside for reference.

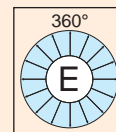
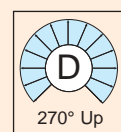
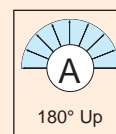
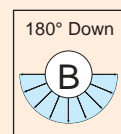

CONNECTIONS DIMENSIONS

Tankwashers are often requested with a clip connection for quick disassembly or with a weld connection for fix location.

Our standard dimensions for these two popular designs are given at page 26.

SINGLE AXIS HEADS

REACTION DRIVE

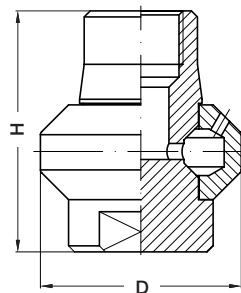

UBB

UBB heads are specially designed for applications where chemical attack from strong acids is to be expected, or when contamination to the product being handled is to be excluded, and are therefore entirely made out of PTFE.

Their rotary motion is produced from the reaction forces of their solid stream water jets, which are arranged in such a way that the inner tank surface is thoroughly covered when the head rotor is in motion.

The simple design, a two-piece construction, assures for long, maintenance free service.

The wide range of capacities and the choice among several spray patterns makes it easy to find the right product to suite a variety of different applications.

The codes shown in the capacity table refer to BSP threads. Our offices can supply coding for products designed with NPT threads.

Coverage code

UBB 2319 E1 ↓ B
 A 180° up
 B 180° down
 E 360°

Material E1 PTFE

LT 95° C

LP 4.0 bar

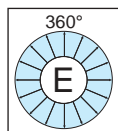
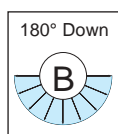
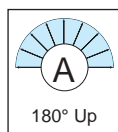

Thread connection

| Code | RF inch | Flow values at different pressures | | | | | WR mm | Dimensions mm | |
|----------------------|---------|------------------------------------|------|------|------|------|-------|---------------|-----|
| | | 1.5 | 2.0 | 2.5 | 3.0 | 3.5 | | H | D |
| UBB 2319 E1EG | 1/2 | 22.6 | 26.0 | 29.2 | 32.0 | 34.6 | 1.0 | 60 | 50 |
| UBB 2320 E1EG | 3/4 | 22.6 | 26.0 | 29.2 | 32.0 | 34.6 | 1.0 | 70 | 60 |
| UBB 2720 E1EG | | 50.9 | 58.8 | 65.7 | 72.0 | 77.8 | 1.5 | | |
| UBB 3120 E1EG | | 85.5 | 98.2 | 110 | 120 | 130 | 1.5 | | |
| UBB 3182 E1EG | | 129 | 149 | 166 | 182 | 197 | 1.8 | | |
| UBB 3198 E1EG | 1 | 140 | 162 | 181 | 198 | 214 | 2.2 | 75 | 70 |
| UBB 3275 E1EG | | 194 | 225 | 251 | 275 | 297 | 2.3 | | |
| UBB 3355 E1EG | | 251 | 290 | 324 | 355 | 383 | 2.3 | | |
| UBB 3395 E1EG | 2 | 279 | 323 | 361 | 395 | 427 | 2.3 | 110 | 124 |
| UBB 3495 E1EG | | 350 | 404 | 452 | 495 | 535 | 2.4 | | |
| UBB 3590 E1EG | | 417 | 482 | 539 | 590 | 637 | 2.4 | | |
| UBB 3690 E1EG | | 488 | 563 | 630 | 690 | 745 | 2.4 | | |
| UBB 3985 E1EG | 3 | 697 | 804 | 899 | 985 | 1064 | 2.4 | 150 | 175 |
| UBB 4118 E1EG | | 834 | 963 | 1077 | 1180 | 1275 | 2.4 | | |
| UBB 4138 E1EG | | 976 | 1127 | 1260 | 1380 | 1491 | 2.4 | | |

Please note the codes given in the above table refer to a 360° spray coverage.

Modify the product code as shown above for different spray coverage.

SINGLE AXIS HEADS

UBC

REACTION DRIVE

UBC series heads are completely made out of stainless steel, with the rotating sphere rolling on two ball bearing rows, to make operation possible in any position.

Inner and outer surfaces are carefully machined, deburred, cleaned and polished to a precisely defined roughness grade to avoid contamination from bacterial growth.

UBC series heads are available with different connection designs, that is a female thread and a clip-on connection as standard, a weld-on or a tri-clamp connection upon request.

The robust and simple design, the high quality construction, long trouble-free service and remarkable efficiency have made them very popular for general purpose applications, in thousands of applications all over the world.

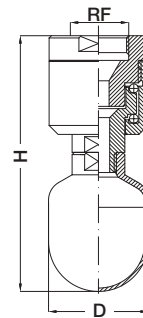

Material **B31** **Aisi 316L Stainless steel**

Thread connection

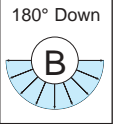
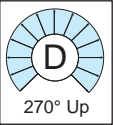
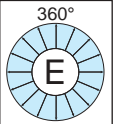
| Code | Capacity at different pressures | | | | lpm bar | Spray pattern deg | | | Thread connection inch | | | | Dimensions mm | | 180° Down  |
|----------------|---------------------------------|------|------|------|---------|-------------------|------|------|------------------------|-----|---|-------|---------------|---|--|
| | 2 | 3 | 5 | 7 | | 360 | 270U | 180D | 1/2 | 3/4 | 1 | 1 1/4 | H | D | |
| UBC 2629 B31BG | 51.4 | 63.0 | 77.7 | 91.2 | | | • | • | | | | 114 | 45 | | |
| UBC 2630 B31BG | 51.4 | 63.0 | 77.7 | 91.2 | | | • | • | • | | | | | | |
| UBC 2899 B31EG | 73.5 | 90.0 | 116 | 131 | • | | | • | | | | | |  | |
| UBC 2900 B31CG | 73.5 | 90.0 | 116 | 131 | | • | | • | | | | | | | |
| UBC 2900 B31EG | 73.5 | 90.0 | 116 | 131 | • | | | • | | | | | | | |
| UBC 3120 B31BG | 98.0 | 120 | 155 | 183 | | | • | | | • | | | | | |
| UBC 3120 B31CG | 98.0 | 120 | 155 | 183 | | • | | | | • | | | | | |
| UBC 3120 B31EG | 98.0 | 120 | 155 | 183 | • | | | | | • | | | | | |
| UBC 3135 B31EG | 110 | 135 | 165 | 195 | • | | | • | | | | | |  | |
| UBC 3300 B31EG | 245 | 300 | 388 | 457 | • | | | | | | • | 130 | 60 | | |

Clip-on connection

| Code | Capacity at different pressures | | | | lpm bar | Spray pattern deg | | | Clip connection pipe size | | Dimensions mm | |
|----------------|---------------------------------|------|------|------|---------|-------------------|------|------|---------------------------|------|---------------|----|
| | 2.0 | 3.0 | 5.0 | 7.0 | | 360 | 270U | 180D | DN25 | DN40 | H | D |
| UBC 2630 B31BC | 51.4 | 63.0 | 77.7 | 91.2 | | | • | • | | | 137 | 45 |
| UBC 2900 B31CC | 73.5 | 90.0 | 116 | 131 | | • | | • | | | | |
| UBC 2900 B31EC | 73.5 | 90.0 | 116 | 131 | • | | | • | | | | |
| UBC 3120 B31CC | 98.0 | 120 | 155 | 183 | | • | | • | | | | |
| UBC 3120 B31EC | 98.0 | 120 | 155 | 183 | • | | | • | | | | |
| UBC 3180 B31CG | 146 | 180 | 233 | 275 | | • | | • | | | | |
| UBC 3300 B31EG | 245 | 300 | 388 | 457 | • | | | | • | | 159 | 65 |

See clip dimensions for UBC models at page 26.

SINGLE AXIS HEADS

REACTION DRIVE

UBD

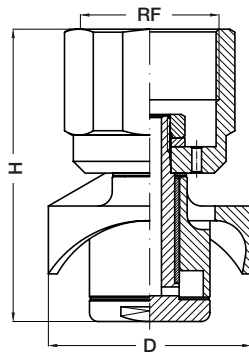

Materials

Body,

shaft and rotary head B31 Aisi 316L Stainless steel
L61 Hastelloy C22

Bearings

E1 PTFE

UBD rotary heads can profit from the special design of their rotary head, which allows for a very even water distribution, assuring optimum surface coverage.

They assure therefore very short washing cycles, using lower quantities of water, with a definite advantage in those applications where recycled water is not allowed as a washing medium, and the volumes sent to disposal must be kept to a minimum.

UBD heads work using Teflon slide bearings floating at high speed over a thin water film, the only wear part being an easily replaceable Teflon washer.

Only a fraction of the liquid energy is then used to power the washing head, while the high speed of the rotating disc produces instantly a cloud of high energy droplets all over the inside surface of the tank.

The clever design of this device results in no maintenance at all being necessary. Large inside passages are not easily subject to plugging while an extremely simple design with only one moving part avoids any internal jamming.

All inside and outside surface are carefully polished, for fast and easy sanitizing. The two following tables give data about types with threaded connection and clip-on types.

Thread connection

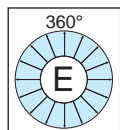
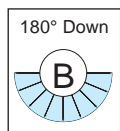
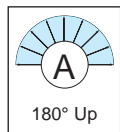

| Code | Capacity at different pressures | | | | | lpm bar | Spray pattern deg | | | Thread connection inch | | | | Dimensions mm | |
|----------------|---------------------------------|------|------|------|------|---------|-------------------|------|------|------------------------|-----|---|-----|---------------|---|
| | 2.0 | 3.0 | 4.0 | 5.0 | 7.0 | | 360 | 180U | 180D | 1/4 | 3/4 | 1 | 1/2 | H | D |
| UBD 0035 B31EG | 28.6 | 35.0 | 41.0 | 45.0 | 53.5 | • | | | • | | | | 54 | 36 | |
| UBD 0051 B31EG | 40.8 | 50.0 | 57.9 | 64.5 | 76.4 | • | | | | • | | | 55 | 35 | |
| UBD 0051 B31AG | 40.8 | 50.0 | 57.9 | 64.5 | 76.4 | | • | | | • | | | | | |
| UBD 0051 B31BG | 40.8 | 50.0 | 57.9 | 64.5 | 76.4 | | | • | | • | | | | | |
| UBD 0090 B31EG | 73.5 | 90.0 | 104 | 116 | 137 | • | | | | | • | | 75 | 51 | |
| UBD 0090 B31AG | 73.5 | 90.0 | 104 | 116 | 137 | | • | | | | • | | | | |
| UBD 0090 B31BG | 73.5 | 90.0 | 104 | 116 | 137 | | | • | | | • | | | | |
| UBD 0141 B31EG | 114 | 140 | 162 | 180 | 213 | • | | | | | | • | 105 | 68 | |
| UBD 0141 B31AG | 114 | 140 | 162 | 180 | 213 | | • | | | | | • | | | |
| UBD 0141 B31BG | 114 | 140 | 162 | 180 | 213 | | | • | | | | • | | | |
| UBD D210 B31EG | 177 | 210 | 240 | 259 | 275 | • | | | | | | • | | | |

1/4" models have PTFE rotary head

Models with clip-on connection available on request. See clip dimensions for UBD models at page 26.

SINGLE AXIS HEADS

UBD/A

REACTION DRIVE

UBD-A rotary heads are a simple but very efficient device for the inside cleaning of tanks. The rotary disk is rotated through the action of the cleaning fluid and produces a very dense spray which reaches all parts of the inside surface, it is the only mobile part of the unit and requires no servicing at all.

No lubrication is required, and therefore no risk exists of contaminating your product with oil or grease.

The device is not easily clogged tanks to a minimum internal passage of 2 mm dia, and will continue to operate even when feed holes are partially closed. Ideally suited for aggressive environments, it operates efficiently with all detergents and chemical solutions, in both closed and open tanks because available with 360 or 180 degrees spray patterns.

UBD-A models find their application in pharmaceutical, chemical and food industries, where pure PTFE complies with the requirements of FDA CFR21.

Models made out of Carbon filled PTFE do not allow for the build up static electricity and can be employed in atmospheres where an explosion risk occurs.

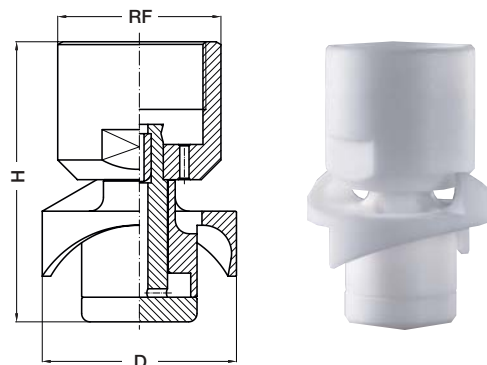

LT 95° C

- Materials
- E1 PTFE, pure
 - E22 PTFE, 25% carbon filled
 - D9 PEEK

Thread connection

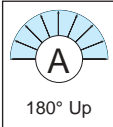
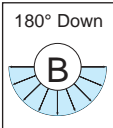
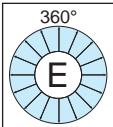
| Code | Capacity at different pressures | | | | | Spray pattern deg | | | Thread connection inch | | | | Dimensions mm | |  |
|---------------|---------------------------------|------|-----|------|------|-------------------|------|------|------------------------|-----|---|-------|---------------|----|---|
| | 2.0 | 3.0 | 4.0 | 5.0 | 6.0 | 360 | 180U | 180D | 1/4 | 3/4 | 1 | 1 1/2 | H | D | |
| UBD A035 xxEG | 28.6 | 50 | | 45.2 | 53.5 | • | | | • | | | | 50 | 30 |  |
| UBD A090 xxEG | 73.5 | 90.0 | 104 | 116 | 137 | • | | | | • | | | 55 | 40 | |
| UBD A090 xxAG | 73.5 | 90.0 | 104 | 116 | 137 | | • | | | • | | | 75 | 51 |  |
| UBD A090 xxBG | 73.5 | 90.0 | 104 | 116 | 137 | | | • | | • | | | | | |
| UBD A140 xxEG | 114 | 140 | 162 | 180 | 213 | • | | | | • | | | | | |
| UBD A140 xxAG | 114 | 140 | 162 | 180 | 213 | | • | | | • | | | 100 | 70 | |
| UBD A140 xxBG | 114 | 140 | 162 | 180 | 213 | | | • | | • | | | | | |
| UBD A210 xxEG | 171 | 210 | 243 | 271 | 320 | • | | | | | • | | | | |
| UBD A210 xxAG | 171 | 210 | 243 | 271 | 320 | | • | | | | • | | | | |
| UBD A210 xxBG | 171 | 210 | 243 | 271 | 320 | | | • | | | • | | | | |

SINGLE AXIS HEADS

REACTION DRIVE

UBX

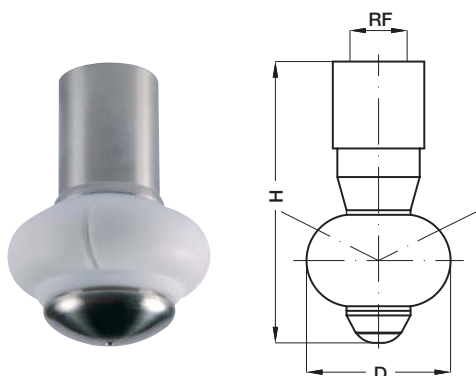

UBX is a very compact product whose design provides for a specially accurate cleaning of the upper area of the tank around the inlet pipe, which is accomplished by a larger rotating head and straight jets with a well studied and appropriate orientation.

Because of the low flow values, the simple design and the high quality surface finish UBX tankwashers are preferred in such application as washing small volume tanks in pharmaceutical processes.

The rotation is obtained by liquid reaction forces, while the head rotates over a thin liquid film which is self-cleaning.

Connection can be threaded or with standard PNR clip for easy disassembly and cleaning.

Materials Body B31 AISI 316L Stainless steel
 Rotor B31 AISI 316L Stainless steel
 E1 PTFE

Thread connection

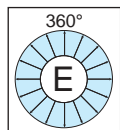
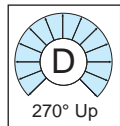
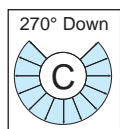

| Code | Capacity at different pressures | | | | | lpm bar | Spray pattern deg | | | Thread connection inch | | | | Dimensions mm | |
|----------------|---------------------------------|------|------|------|------|---------|-------------------|------|------|------------------------|-----|-----|-----|---------------|----|
| | 2.0 | 3.0 | 4.0 | 5.0 | 6.0 | | 360 | 270D | 270U | 1/4 | 3/8 | 1/2 | 3/4 | H | D |
| UBX A20S B31EG | 16.3 | 20.0 | 23.1 | 25.8 | 28.3 | • | | | • | | | | | 52 | 25 |
| UBX A20S B31CG | 16.3 | 20.0 | 23.1 | 25.8 | 28.3 | | • | | • | | | | | | |
| UBX A20S B31DG | 16.3 | 20.0 | 23.1 | 25.8 | 28.3 | | | • | • | | | | | | |
| UBX A30S B31EG | 24.5 | 30.0 | 34.6 | 38.7 | 42.4 | • | | | | • | | | | 64 | 32 |
| UBX A30S B31CG | 24.5 | 30.0 | 34.6 | 38.7 | 42.4 | | • | | | • | | | | | |
| UBX A30S B31DG | 24.5 | 30.0 | 34.6 | 38.7 | 42.4 | | | • | | • | | | | | |
| UBX A40S B31EG | 32.7 | 40.0 | 46.2 | 51.6 | 56.6 | • | | | | | • | | | 75 | 38 |
| UBX A40S B31CG | 32.7 | 40.0 | 46.2 | 51.6 | 56.6 | | • | | | | • | | | | |
| UBX A40S B31DG | 32.7 | 40.0 | 46.2 | 51.6 | 56.6 | | | • | | | • | | | | |
| UBX A70S B31EG | 57.1 | 70.0 | 80.8 | 90.4 | 99.0 | • | | | | | | • | | 100 | 50 |
| UBX A70S B31CG | 57.1 | 70.0 | 80.8 | 90.4 | 99.0 | | • | | | | | • | | | |
| UBX A70S B31DG | 57.1 | 70.0 | 80.8 | 90.4 | 99.0 | | | • | | | | • | | | |

SINGLE AXIS HEADS

SMALL DIMENSION WASHING HEADS

UBF range heads have been designed as small dimensions devices to be operated through small dimension openings and perform such processes as the inside cleaning of any other container where standard washing heads cannot be used. Typically used for cleaning beer kegs, containers for soft drinks or small bore pipes. The device passes through a one inch (25.4 mm) diameter bore.

Material B31 Aisi 316L Stainless steel

EXCLUSIVE TRUMPET ORIFICE

The new trumpet design of the side orifices allows to obtain a more efficient fan shaped jet, with a well defined spray angle, improving considerably the washing action. Italian and International Patents applied for.

REACTION DRIVE

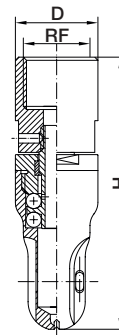

| Code | RF inch | Flow values at different pressures | | | | | lpm bar | Spray pattern deg | | Dimensions mm | |
|----------------|---------|------------------------------------|------|------|------|------|---------|-------------------|------|---------------|---|
| | | 3 | 4 | 5 | 10 | 12 | | 180H | 270D | H | D |
| UBF 2270 B31DG | 1/2 | 22.0 | 27.0 | 36.4 | 51.5 | 56.4 | • | | 88 | 25 | |
| UBF 2380 B31DG | | 31.0 | 38.0 | 49.2 | 69.3 | 76.0 | | • | | | |

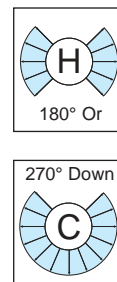

UBF A

Designed for cleaning processes in small bore piping or small size containers and available in a range of different plastic materials and special alloys, as well as with several spray angles.

Materials D81 PVDF (standard)
 B31 AISI 316L Stainless steel
 E1 PTFE (Teflon)
 L61 Hastelloy C22

| Code | RF inch | Capacity at pressures | | | lpm bar | Spray pattern deg | | | Dimensions mm | |
|----------------|---------|-----------------------|------|------|---------|-------------------|------|-----|---------------|---|
| | | 2.0 | 3.0 | 4.0 | | 180D | 270U | 360 | H | D |
| UBF A250 D81BG | 1/2 | 20.0 | 25.0 | 28.8 | • | | | 80 | 25 | |
| UBF A250 D81DG | | 20.0 | 25.0 | 28.8 | | • | | | | |
| UBF A250 D81EG | | 20.0 | 25.0 | 28.8 | | | • | | | |

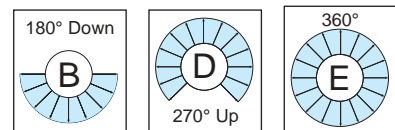
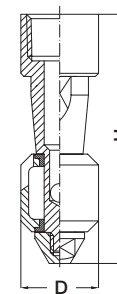

UBF S

Designed for cleaning processes in very small bore piping or containers, down to 15 mm diameter. The device is available in different materials as well as spray angles.

Materials B31 Aisi 316L Stainless steel
 E1 PTFE (Teflon)

| Code | RF inch | Capacity at pressures | | | lpm bar | Spray pattern deg | Dimensions mm | |
|---------------|---------|-----------------------|------|-----|---------|-------------------|---------------|---|
| | | 2.0 | 3.0 | 4.0 | | | H | D |
| UBF S055 xxDG | 1/8 | 4.50 | 5.50 | 6.4 | • | 33 | 13 | |

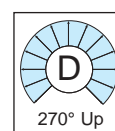
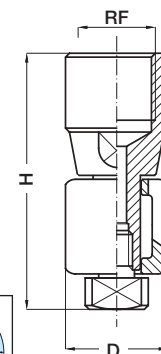

SINGLE AXIS HEADS

MOTOR DRIVE

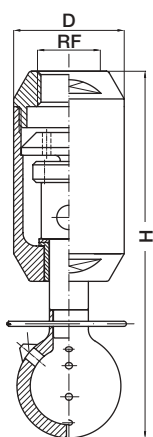

UBA

UBA series heads operate producing water jets out of a spray head rotating around a vertical axis, but feature a sophisticated design where the head is put in slow motion by a simple friction motor.

As the motor produces a low rotation velocity, the jets can work with their maximum efficiency since not being broken into droplets: this makes it possible to obtain a higher impact force onto the tank wall. The head design can include one jet directed upwards which is meant to clean the tank roof area around the feed pipe, a difficult area in many instances, realizing then a true 360° spray pattern.

Superior cleaning power, faster cleaning cycles and lower volumes of cleaning solution required. UBA washing heads are available in two sizes, and two different jet patterns, as shown in the diagram below.

Rotation speed varies, depending upon feed pressures, between 5 and 12 rpm.

Materials Body and sphere B31 AISI 316L Stainless steel
 Bushings E1 PTFE
 Motor ring E1 PTFE

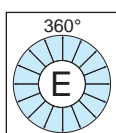
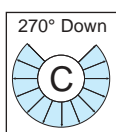

| Code | RF inch | Capacity at different pressures | | | | Spray pattern deg | | Dimensions mm | |
|----------------|------------|---------------------------------------|------|------|------|----------------------|-----|------------------|----|
| | | 3.0 | 5.0 | 7.0 | 10 | 270 D | 360 | H | D |
| UBA 2500 B31CG | 3/4 | 50.0 | 64.5 | 76.3 | 91.3 | • | | 165 | 47 |
| UBA 2500 B31EG | | 50.0 | 64.5 | 76.3 | 91.3 | | • | | |
| UBA 3150 B31EG | 1 1/2 | 150 | 193 | 228 | 273 | | • | 230 | 70 |

TWIN AXIS HEADS

POSITIVE DRIVE

The most sophisticated tank washing equipment, where high impact fluid jets slowly move with a combined rotation around one vertical and one horizontal axis.

The motive mechanism assures the jet to hit always different paths at each turn, so that each single point of the inner tank surface is surely cleaned.

Our unique range includes different models to suit any requirement in the industry, with low and high pressure jets and a choice among positive drive actuated from the washing liquid itself, or external motors both electric or compressed air motors.

EXTERNAL DRIVE MODELS

A well known solution within the chemical industry, where the parts inside the tank require no maintenance, the drive unit outside the tank is easily serviced and repaired and can be chosen among an electric or compressed air motor according to the plant operating environment.

Page 16



TURBINE DRIVE MODELS (BUTTERWORTH)

A very sophisticated product, where high quality machining assures for perfect operation and impeccable surface quality, preferred in the chemical and pharmaceutical industry where there cannot be any compromise on safe and reliable operation.

Page 17



HIGH PRESSURE MODELS

A sturdy construction, ideal for such application as truck tank washing, massive stainless steel cast body and highly efficient high pressure jets for intensive surface scrubbing.

Page 19



CLEANING VALIDATION

Together with our sophisticated tankwashers we take pride in making available some of the most modern and reliable equipment to validate the result of the cleaning process with an high technology equipment.

We offer portable and standing control equipment based on luminometry measurement.

Page 20



TWIN AXIS HEADS

POSITIVE DRIVE

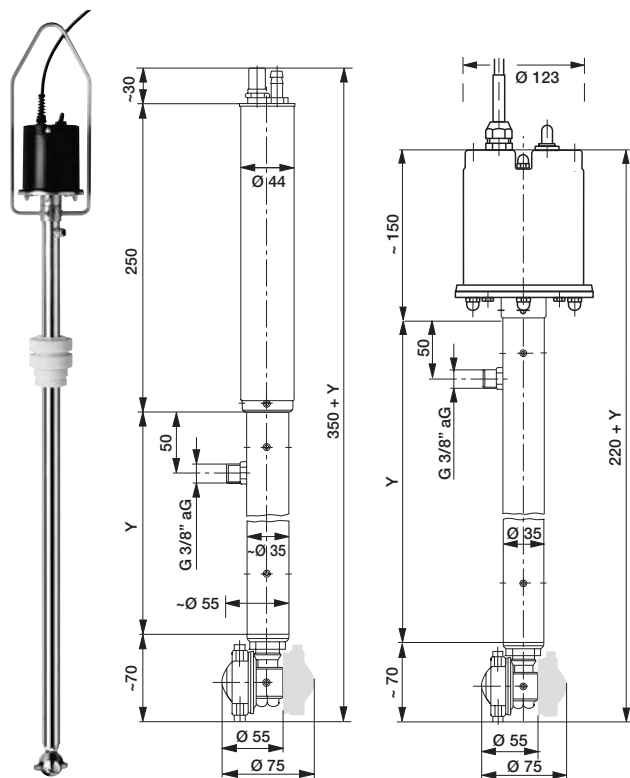

UBG

These proven units are powered from electric or compressed air motors located outside the tank, and assure the most reliable washing operation where the only shaft is protruding inside the tank.

The high quality motors and the stainless steel mechanism assure for years long trouble-free service, while a choice of models covers a wide application requirement range, with pressures up to 250 bar and capacities to 80 lpm, different shaft lengths and choice between 2 or 4 nozzles heads to better suit your washing cycle specifications.

The liquid capacity depends upon the size of its spray nozzles. Capacities for several sizes of nozzles are given in the table below, where the capacity is understood for a head equipped with two nozzles of the given size, and it must be doubled for double heads fitted with four nozzles.

Shaft lengths 1.0, 1.5 or 2.0 meters, see drawings for total length. Accessories, and specifications about air and electric motors, can be found at page 13.

Materials

Mechanical parts B3 Aisi 316 stainless steel

TANKWASHER CODE

UBG tankwashers code includes all the possible options, and it must be completed by means of the table below, choosing the appropriate value for X, Y and Z.

UBG 12 x y B3 z B

Please complete the code as follows

- X Motor type A = Air E = Electric
- Y Shaft length A = 1.0 m B = 1.5 m C = 2.0 m
- Z Tank mount A = Adapter B = Threaded ring C = Flange Z = None

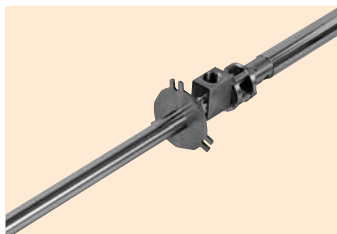

We supply mounting flanges to Customer design, or to any international Standard.

| Code | NZ | Capacity at different pressures | | | | | | | Dimensions | | |
|----------------|----|---------------------------------|----|----|----|----|----|-----|------------|----|----|
| | | 10 | 20 | 30 | 50 | 70 | 90 | 135 | lpm bar | TL | DL |
| UBG 12xy B3 zB | 05 | 7 | 10 | 12 | 16 | 19 | 22 | 27 | 55 | 75 | 1" |
| UBG 18xy B3 zB | 06 | 9 | 12 | 15 | 19 | 23 | 26 | 32 | | | |
| UBG 24xy B3 zB | 07 | 10 | 14 | 17 | 22 | 27 | 30 | 37 | | | |
| UBG 36xy B3 zB | 08 | 12 | 16 | 20 | 26 | 31 | 35 | 43 | | | |
| UBG 48xy B3 zB | 09 | 13 | 18 | 23 | 29 | 34 | 39 | 48 | | | |
| UBG 54xy B3 zB | 10 | 14 | 20 | 25 | 32 | 38 | 43 | 53 | | | |

Capacity values shown in the table only show the highest value that can be obtained through a rotating head fitted with two nozzles having the size shown under the column NZ.

The precise capacity being sprayed into the tank depends upon friction losses between the pump outlet and the nozzles.

Additional technical details are given at page 13.

TWIN AXIS HEADS

UBN A

POSITIVE DRIVE

UBN tankwashers are a very sophisticated model of automatic machines for cleaning the inside of tanks and process vessels.

The units are operated through an inside turbine powered by the cleaning fluid, which moves a gear system to obtain reduced speed and increased torque, setting the head into rotation with the proper speed to assure a perfect cleaning action.

The careful design assures that a pattern matrix is brushed by the moving jets onto the inner tank surface so that complete inner surface of the tank is properly treated: this result is attained after 65 axial revolutions of the head.

To ease keeping strict hygienic conditions BC tankwashers offer as standard an external surface finish grade equal or better than 25 Ra.

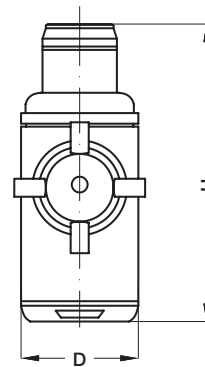

| | |
|-----------|--|
| Materials | AISI 316 Stainless steel Duplex Stainless steel |
| LT | 150° C |
| LP | 21 bar |

| Code | Thread inch | Capacity at different pressures | | | | | | | | lpm bar | Nozzles lay-out | Dimensions mm | |
|---------------|----------------|------------------------------------|-----|-----|-----|-----|-----|-----|-----|------------|--------------------|------------------|---|
| | | 3.0 | 4.0 | 5.0 | 6.0 | 8.0 | 10 | 12 | 15 | | | H | D |
| UBN A06L B3SG | 1 1/2 | 60 | 68 | 72 | 79 | 83 | 99 | 102 | 106 | L 4 x 3.0 | 220 | 95 | |
| UBN A10L B3SG | | 98 | 105 | 113 | 117 | 125 | 143 | 147 | 151 | L 4 x 4.0 | | | |
| UBN A14L B3SG | | 140 | 151 | 162 | 174 | 181 | 208 | 215 | 223 | L 4 x 5.0 | | | |
| UBN A20L B3SG | | 193 | 212 | 227 | 238 | 249 | 286 | 295 | 310 | L 4 x 6.0 | | | |
| UBN A07L B3SG | | 79 | 87 | 91 | 98 | 106 | 125 | 128 | 132 | L 2 x 5.0 | | | |
| UBN A11L B3SG | | 106 | 117 | 125 | 132 | 140 | 159 | 166 | 174 | L 2 x 6.0 | | | |

For tanks ranging from 5 to 170 cubic meters

TWIN AXIS HEADS

POSITIVE DRIVE

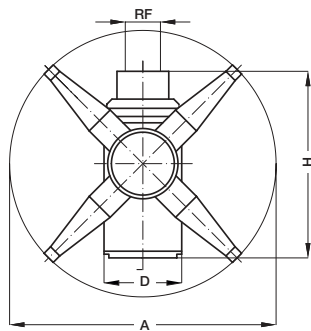

UBN C

UBN C tankwashers are a very sophisticated model of automatic machines for cleaning the inside of tanks and process vessels with high capacity values.

The units are operated through an inside turbine powered by the cleaning fluid, which moves a gear system to obtain reduced speed and increased torque, setting the head into rotation with the proper speed to assure a perfect cleaning action.

The careful design assures that a pattern matrix is brushed by the moving jets onto the inner tank surface so that complete inner surface of the tank is properly treated: this result is attained after 65 axial revolutions of the head.

To ease keeping strict hygienic conditions BC tankwashers offer as standard an external surface finish grade equal or better than 25 Ra, while some models can be delivered with self-rinsing design.

Materials **AISI 316 Stainless steel**
 Duplex Stainless steel
LT **150° C**
LP **21 bar**

| Code | Thread inch | Capacity at different pressures | | | | | | | | Nozzles lay-out | Dimensions mm | |
|---------------|----------------|------------------------------------|-----|-----|-----|-----|-----|-----|-----|--------------------|------------------|-----|
| | | 3.0 | 4.0 | 5.0 | 6.0 | 8.0 | 10 | 12 | 15 | | H | D |
| UBN C070 B3SG | 1 1/2 | 72 | 83 | 87 | 98 | 106 | 113 | 121 | 128 | 2 x 6.0 | 196 | 300 |
| UBN C110 B3SG | | 106 | 132 | 147 | 159 | 189 | 219 | 238 | 265 | 2 x 8.0 | | |
| UBN C150 B3SG | | 181 | 227 | 253 | 276 | 310 | 351 | 389 | 446 | 2 x 10 | | |
| UBN C160 B3SG | | 147 | 178 | 197 | 204 | 223 | 253 | 272 | 295 | 4 x 6.0 | | |
| UBN C200 B3SG | | 197 | 234 | 257 | 268 | 291 | 332 | 355 | 389 | 4 x 7.0 | | |
| UBN C260 B3SG | | 254 | 302 | 332 | 351 | 378 | 431 | 461 | 495 | 4 x 8.0 | | |
| UBN C300 B3SG | | 283 | 359 | 397 | 435 | 484 | 559 | 616 | 680 | 2 x 12 | | |

TWIN AXIS HEADS

UBS

POSITIVE DRIVE

UBS heads have been designed to fulfill the requirements of those applications where intensive washing cycles at high pressure need to be performed. The sturdy stainless steel case houses an high precision driving mechanism based on an high speed turbine, operated by the washing liquid itself, and an epicycloid reduction gearbox. The gear ratio is expressly chosen so as to obtain a given pitch between the paths covered at each turn of the water jets. This design ensures that the inside surface of the tank is thoroughly cleaned, with an homogeneous result all over.

This well proven design, coupled with high precision machining, assures for a long, trouble-free operation life. It is, however, recommended to protect the head from premature wear damage using the cleanest possible washing solution. An inlet water filter (0.6 mm/38 mesh) is built inside the feed port, being the only part requiring to be cleaned regularly: it avoids large size foreign particles to enter the device.

UBS heads can be supplied to cope with a wide variety of capacity requirements: several inner setup values, based on the turbine feed injectors are available on request. For any required capacity (lpm) the injectors bore value can be selected in order to obtain a rotary velocity value within the recommended operation range of 10 to 15 (rpm). The diagram below gives the capacity in lpm and the rotary speed in rpm, based on the different available injector sizes: please note the injector size set-up can only be modified at the factory.

Each head model is supplied complete with four straight jet high pressure nozzles having the capacity size value shown in the table beside.

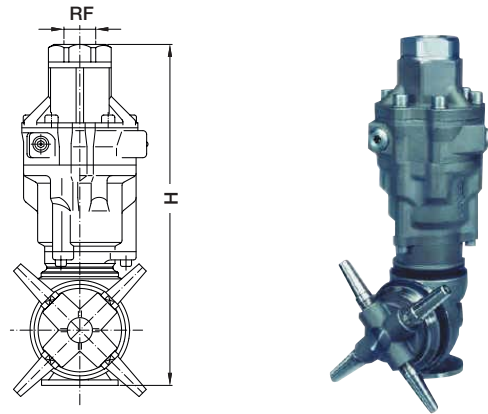

| Code | Injector setup mm | Capacity lpm | Nozzle size | Weight kg |
|---------------|-------------------|--------------|-------------|-----------|
| UBS A025 B1EG | 3 x 2.0 | 25 | 025 | 5.3 |
| UBS A030 B1EG | 3 x 2.5 | 30 | 03 | |
| UBS A040 B1EG | 3 x 3.0 | 40 | 04 | |
| UBS A050 B1EG | 3 x 4.0 | 50 | 045 | |
| UBS A065 B1EG | 3 x 5.0 | 65 | 06 | |
| UBS A080 B1EG | 3 x 6.0 | 80 | 07 | |
| UBS A100 B1EG | 3 x 7.0 | 100 | 09 | |
| UBS A110 B1EG | 3 x 8.0 | 110 | 11 | |
| UBS A120 B1EG | 3 x 9.0 | 120 | 15 | |

Above capacity values are given for a max rotary speed of 15 rpm and feed pressure value 140 bar

Operational conditions Water pressure max 140 bar
Water temperature max 90° C

Material Head B2 Aisi 304 Stainless steel
Wash nozzles C2 Aisi 416 hardened

Operation example

With a pump delivering 50 lpm the head can be operated with three different set-ups:

- Injectors 7.0 mm, speed 10 rpm
- Injectors 6.0 mm, speed 12 rpm
- Injectors 5.0 mm, speed 15 rpm

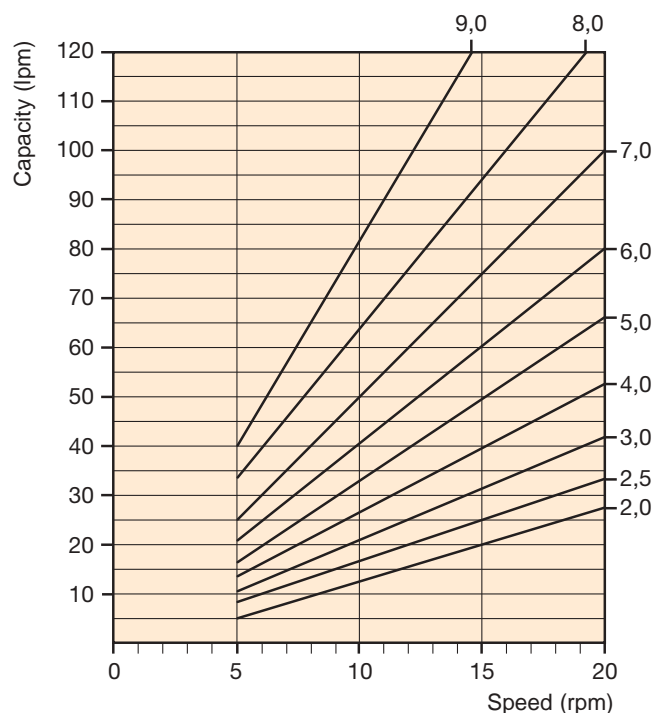

CLEANING VALIDATION



The efficiency of all cleaning operation in the food, dairy and beverage industries can be easily validated and the results recorded by means of our range of instruments for ATP detection.

The instrumentation works on the ATP (Adenosine TriPhosphate) methodology, where ATP is a substance present into all living matter like animal, plant or microbes.

The quantity of ATP present in the rinse water collected from the inside of a tank can be easily sampled making it react with chemical reagents and luciferine so that a chemically originated light is produced.

The light is measured with a luminometer, and the value given by the instruments can be taken as a reliable indicator of the purity of the water, or the contamination inside the tank.

The test process is extremely simple, all it takes is dipping a sample cartridge into a glass containing the water to be tested, and the results is available in about 30 seconds.

INSTRUMENTS

A range of hand-held of table instruments are available, together with the sampling cartridges and all the accessories like printers, software for storing multiple test results and the like.

HAND-HELD LUMINOMETER

Uni-lite NG reads and stores results for later examination

| | |
|-------------|---|
| Weight | 400 grs |
| Reading | 30 s |
| Accessories | Docking station Carrying case Printer |



BIO-TRAK SOFTWARE

It is designed to receive, store and examine the results collected by the hand-held Uni-lite, produce sorting, charts and graphs in order to allow perfect monitoring of the hygiene control data.

| | |
|---------------------|---|
| Additional features | Upload of control plans into Uni-lite portable instrument Conversion of data into Excel or Word formats Sorting of historical data Transferring of data via e-mail |
|---------------------|---|



PRODUCT RANGE

Our hygiene testing product range includes many other products like table instrumentation, different reagents for liquids containing particulates and fibers, products allowing to detect contamination from a surface or positive controls for instrumentation efficiency.

Please contact the nearest PNR office for additional information.

WRITTEN EVIDENCE

Each single cleaning operation can be certified with a written diagram recording the load of contaminating material found into the sample liquid after the different steps of cleaning operation, and the corresponding time for future evidence.

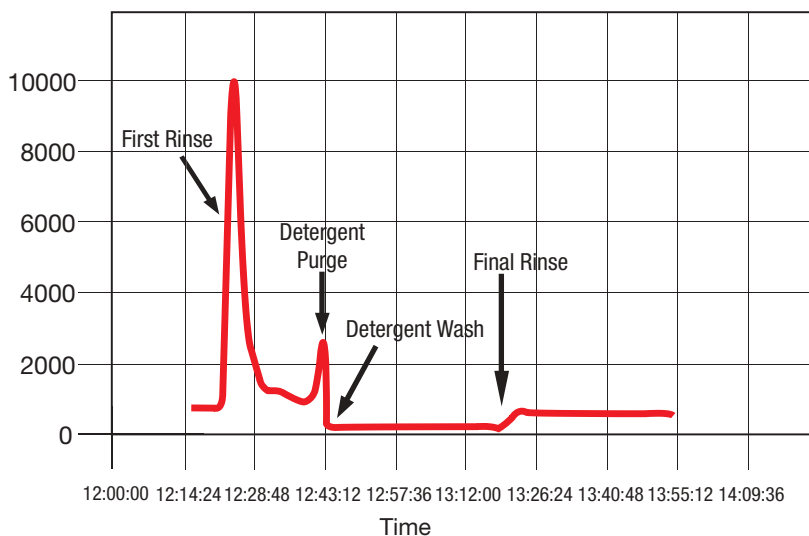

AUXILIARY EQUIPMENT

UMV

The UMV series washgun has been designed primarily to avoid hot water waste, while assuring very comfortable operation conditions. Its thick rubber casing not only effectively protects the operator's hand from the discomfort of hot water but also assures an excellent protection in case the washgun is dropped or falls to the ground since it avoids any damage to the tiles or the equipment. The careful design, mainly used for the food industry, also includes a grease and detergent resistant quality rubber, plus a blue colour has been chosen as a visual aid to be seen clearly against a white or clear foreground. The trigger is lined too, and can be held in the open position by means of a lock-ring. The spray pattern can be adjusted continuously between a closed straight jet to a wide angle spray, so that the proper spray pattern can be chosen for each individual job.

Materials

| | |
|-------------------|--|
| Body | T2 Brass casting, chrome plated |
| | B3 AISI 316 Stainless Steel |
| Lining | E0 EPDM |
| Stem | B3 AISI 316 Stainless steel |
| Trigger | B3 AISI 316 Stainless steel, rubber lined |
| | LT 80° C |
| | LP 25 bar |
| | LQ 21 lpm @ 3 bar UMV 2210 |
| | 61 lpm @ 3 bar UMV 2211 |
| Hose shank | 13 mm – 1/2" hose fitting |
| Weight | 0.9 kg |

HOT WATER GUN

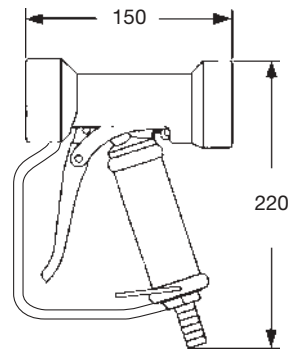

UMV 2210 xx

The versatility of this washgun is enhanced from the additional model UMV 2211, which can be fitted with nozzles or different lances through its 1/2" female thread. The three different lance models shown are easily fitted to the gun body with a 1/2" male nipple and offer the following choices of operation:

- 1 Foaming machines and equipment prior to washing operations. The foam lance comes with a quick connect female coupling, and a matching coupling must be fitted at the gun outlet.
- 2 General purpose 1/4" fem thread outlet, 1/4" male thread inlet. Available both with heat protection sleeve, or zinc-plated steel. The general purpose lance needs a connection nipple 1/4" fem to 1/2" male to be fitted on the gun. Please see the complete washgun and components codes below.

| Complete guns | |
|--------------------|--|
| UMV 2210 xx | Standard, adjustable jet |
| UMV 220A xx | With foam lance |
| UMV 220B xx | With 1/4" fem outlet, bare lance |
| UMV 220C xx | With 1/4" fem outlet, heat protected lance |

| Single components | |
|--------------------|--|
| UMV 2211 xx | With 1/2" female quick thread, without lance |
| XUM V001 B3 | Foam lance |
| XUM V002 B3 | Quick connect coupling for foam lance, 1/2" M |
| XUM V003 B3 | Universal lance, 1/4" F out, heat protection |
| XUM V004 B3 | Universal lance, 1/4" F out, zinc-plated steel |
| XUM V005 T2 | Nipple, 1/4" F – 1/2" M, chrome plated brass |

Please complete product codes , ending with (xx), filling in the code of required material eg **T2**, chrome plated brass, or **B3** for AISI Stainless steel 316.



UMV 2211 xx + **XUM V002 B3** + **XUM V001 B3** =

UMV 220A T2

+ **XUM V005 B3** + **XUM V004 B3** =

UMV 220B T2

+ **XUM V005 B3** + **XUM V003 B3** =

UMV 220C T2

AUXILIARY EQUIPMENT

STEAM WATER INJECTOR

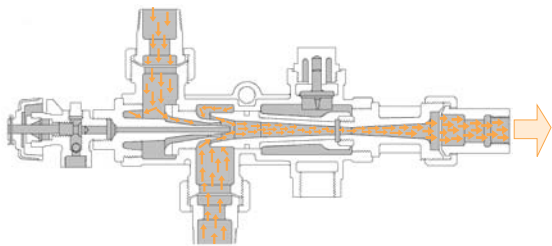
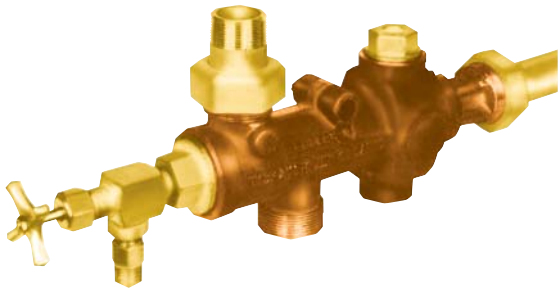

UPM

The UPM steam injector is a remarkable device to be used with washguns and tank washing heads, in those factories where a steam supply is available.

This device converts the steam energy into water pressure, and produces hot water under pressure from cold water at low pressure just adding steam.

Remarkably the hot water pressure can range between 2 and 3 times the inlet steam pressure, therefore saving the cost of purchasing an additional pump, with the following added advantages:

- Detergents can be added into an existing port in the injector body, with aspiration and mixing into the hot water stream is performed automatically, without the cost of additional piping.
- A safety by-pass unloads excess water, or closes the steam line should water supply be interrupted.
- Ideally suited for those areas where the presence of electric motors and electric lines would be hazardous.

Steam pressure 4 to 10 bar
 Steam capacity 125 to 4500 kgph
 Warm water pressure 7 to 25 bar

Material Body T5 Bronze

| Code | Hot water flow rates | lpm |
|-------------|----------------------|-----|
| UPM 2830 T5 | 15 ÷ 83 | |
| UPM 3233 T5 | 116 ÷ 233 | |
| UPM 3633 T5 | 233 ÷ 633 | |

SMALL STEAM HEATERS

UPL steam operated water heaters offer a simple, cheap and noiseless solution to the problem of producing hot water in factories. Simply connecting the mixer inlet to cold water and steam lines assures a ready supply of hot sanitary water for your cleaning processes. All the steam energy is given to the water, the heating processes is extremely efficient and assures a low cost per liter and no stock is needed: just make the quantity you need. Two inlet valves allow for adjusting the temperature value, that can be read on the thermometer in front of the mixer. A safety valve automatically closes the steam inlet in event of water supply absence. Please read User Manual enclosed in the box before operating the units.

Max operation temperature LT 90° C
 Max steam pressure LP 10 bar
 Material B3 AISI 316 Stainless steel

| Code | RFW inch | RFS inch | UF inch | H mm | H1 mm | L mm | W kg |
|-------------|-------------|-------------|------------|---------|----------|---------|---------|
| UPL 0034 B3 | 3/4 | 3/4 | 3/4 | 356 | 183 | 136 | 4,7 |
| UPL 0114 B3 | 1 1/4 | 1 1/4 | 1 1/4 | 530 | 275 | 196 | 15,7 |

Steam inlet

Globe valve PN 25, with metal sealing seat.
 Max temperature 180° C
 Max working pressure 10 bar

Water inlet

Globe valve PN 16, with metal sealing or PTFE seat.

The tables beside give capacity of hot water (Lph) for inlet water temperature of 15° C, as a function of steam pressure.

STEAM WATER INJECTOR

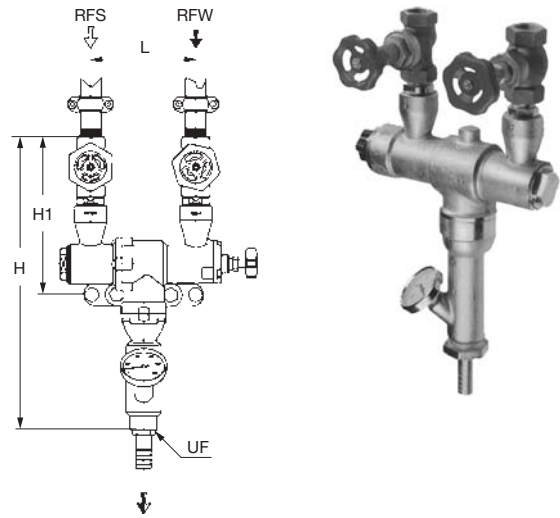

STEAM CONSUMPTION CHART

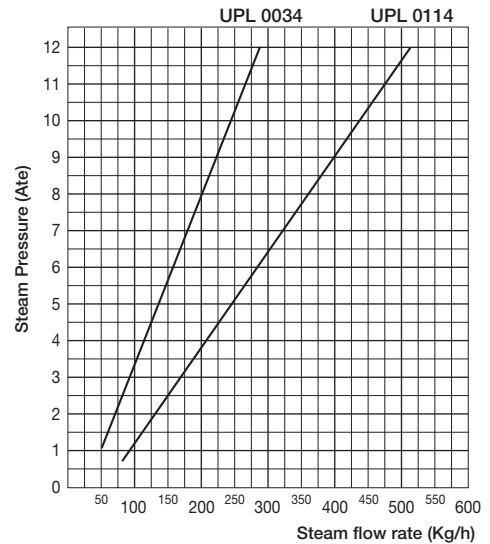

PRESSURE/CAPACITY WATER TEMPERATURE=15° C

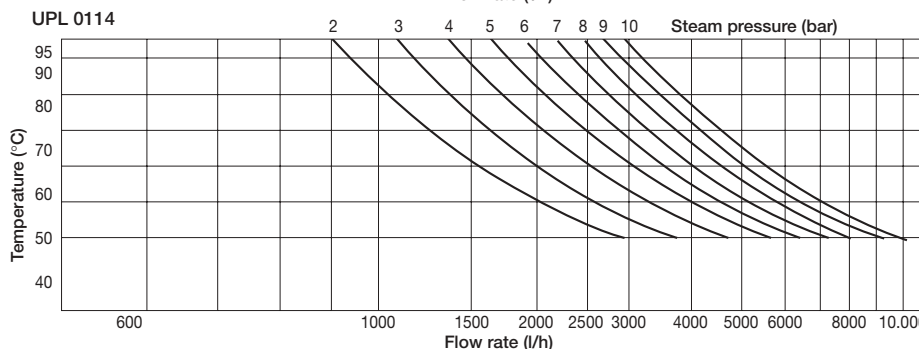
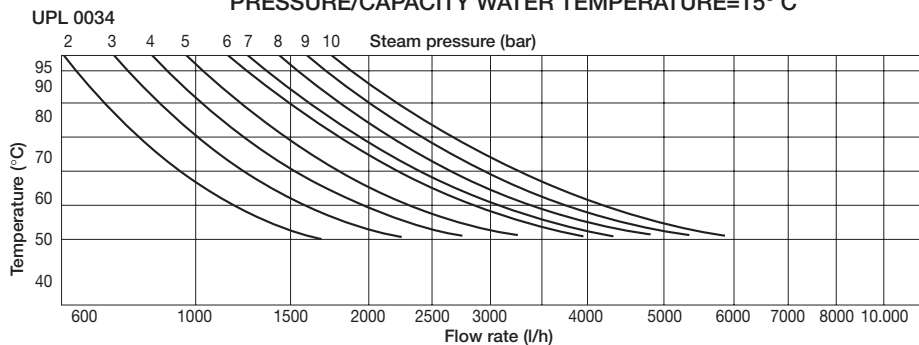

AUXILIARY EQUIPMENT

TANK / DUCT CLEANING

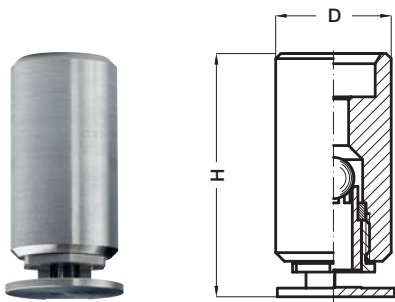

PINTLE NOZZLES

An additional product of interest for cleaning processes. Our range of pintle nozzles is designed for the purpose of staying normally closed with the pintle head protected inside the body, and having the head to pop up producing an effective washing jet when required. This avoids the danger of powders or foreign material to enter the nozzle when washing is not required, and being assured of proper operation in some difficult to reach spot in the system.

A variety of different jet patterns is available, please ask for UAE data sheet.

LINE FILTERS

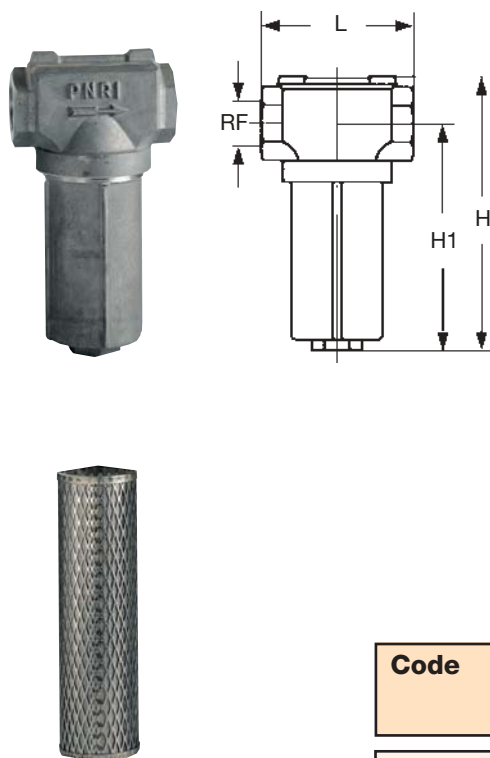

The line filters of the VEM series have been designed to assure high efficiency and ease of maintenance under difficult operating conditions.

The bowl houses large size cartridges, where the large filtering surface allows for extended operation times, and is connected to the filter body by means of a threaded connections for quick removal without tools.

A threaded plug at the bottom of the bowl, allows for fitting a ball valve to bleed filter if so desired.

- Materials**
- Body V1 Aluminum casting (Electroless nickel coated is option)
 - Bowl V1 Aluminum casting (Electroless nickel coating is option)
 - Cartridge B2 Aisi 304 Stainless steel
 - Plug A7 Zinc coated steel
 - Bowl gasket E0 Syntetic rubber

FILTER CARTRIDGES

Please note each filter is to be fitted the proper cartridge, and different mesh sizes are available for a single filter size. In the table beside you have the choice, for each filter size, between several mesh sizes (see under M the values available for mesh size).

| Code | RF inch BSPP | H mm | H1 mm | L mm | LP bar | Q lpm | Cartridge | M mesh | W kg |
|---|--------------------|---------|----------|---------|-----------|----------|---|----------------|---------|
| VEM 0050 V1 VEM 0051 V1 | 1/2 | 210 | 152 | 105 | 40 | 70 | XVE M075 B2 XVE M076 B2 | 60 80 | 0,9 |
| VEM 0075 V1 VEM 0076 V1 | 3/4 | 210 | 152 | 105 | 40 | 95 | XVE M075 B2 XVE M076 B2 | 60 80 | |
| VEM 0100 V1 VEM 0101 V1 | 1 | 210 | 152 | 105 | 40 | 140 | XVE M075 B2 XVE M076 B2 | 60 80 | |
| VEM 0125 V1 VEM 0126 V1 | 1 1/4 | 270 | 210 | 140 | 30 | 280 | XVE M150 B2 XVE M151 B2 | 60 80 | |
| VEM 0150 V1 VEM 0151 V1 | 1 1/2 | 270 | 210 | 140 | 30 | 315 | XVE M150 B2 XVE M151 B2 | 60 80 | |
| VEM 0200 V1 VEM 0201 V1 VEM 0202 V1 | 2 | 400 | 318 | 200 | 10 | 750 | XVE M300 B2 XVE M301 B2 XVE M302 B2 | 30 60 80 | 5,6 |
| VEM 0250 V1 VEM 0251 V1 VEM 0252 V1 | 2 1/2 | 400 | 318 | 200 | 10 | 810 | XVE M300 B2 XVE M301 B2 XVE M302 B2 | 30 60 80 | |
| VEM 0300 V1 VEM 0301 V1 VEM 0302 V1 | 3 | 400 | 318 | 200 | 10 | 1050 | XVE M300 B2 XVE M301 B2 XVE M302 B2 | 30 60 80 | |

TECHNICAL INFORMATION

WETTING RADIUS

PNR MATERIALS CODES

Please see notes on cleaning radius and wetting radius at page 1.

| Code | A deg | GM m | PM mm | W kg |
|----------------------|-----------|-----------|---------|------|
| UBA 2400 B3 | 360 | 3.5 | 3.5 | 0.95 |
| UBA 2402 B3 | 270 | 3.5 | 3.5 | 0.95 |
| UBA 3150 B3 | 360 | 4.5 | 7.0 | 2.40 |
| UBB 2319 E1 | * | 3.0 | 1.4 | 0.12 |
| UBB 2320 E1 | * | 3.0 | 1.4 | 0.12 |
| UBB 3120 E1 | * | 3.0 | 2.0 | 0.16 |
| UBB 3198 E1 | * | 2.7 | 4.0 | 0.25 |
| UBC 2630 B3 | 180 d | 2.7 | 1.3 | 0.55 |
| UBC 2899 B3 | 360 | 2.5 | 1.5 | 0.55 |
| UBC 2900 B3 | 360 | 2.5 | 1.5 | 0.55 |
| UBC 3120 B3 | all types | 2.7 | 1.5 | 0.55 |
| UBC 3135 B3 | 360 | 2.7 | 1.5 | 0.55 |
| UBC 3330 B3 | 360 | 2.3 | 1.7 | 0.95 |
| UBD 2530 B3 | 360 | 2.5 | 1.0 | 0.45 |
| UBD 2780 B3 | all types | 2.5 | 1.0 | 0.45 |
| UBD 2870 B3 | 360 | 2.5 | 1.0 | 0.45 |
| UBD 3125 B3 | 360 | 2.9 | 1.5 | 0.70 |
| UBD 3210 B3 | 360 | 3.5 | 2.0 | 0.90 |
| UBE A087 E1AF | 360 | 2.5 | 1.5 | 0.40 |
| UBE A125 E1AF | 360 | 2.5 | 2.0 | 0.50 |
| UBE A210 E1AF | 360 | 2.8 | 2.5 | 0.75 |
| UBF 2270 B3 | 270 | 1.5 | 2.0 | 0.25 |
| UBF 2380 B3 | 270 | 1.5 | 2.0 | 0.25 |
| UBL 2750 B3 | 360 | 4.5 | 6.0 | 3.50 |
| UBL 3115 B3 | 360 | 4,5 | 8.0 | 3.50 |
| UBS 2700 B2 | 360 | See note* | 0.8/2.7 | 8.50 |

More detailed information on these and other types available from our Offices.

GM = WETTING RADIUS
PM = MINIMUM FREE PASSAGE

NOTE

High pressure tankwashers types (UBG, UBH, UBK and UBS) use straight jet nozzles and their water jets offer much longer reach than low pressure tankwashers.

Under these conditions, however, the water quantity applied per surface unit of the interior tank surface is limited and it would be improper to assign them a wetting radius value, when we intend with such a value the radius of a tank which can be cleaned by a light, even spray of water.

| | |
|-----|------------------------------------|
| A1 | Mild steel |
| A8 | Zinc coated steel |
| A9 | Nickel coated steel |
| B1 | AISI 303 stainless steel |
| B2 | AISI 304 stainless steel |
| B21 | AISI 304 L Stainless steel |
| B3 | AISI 316 Stainless steel |
| B31 | AISI 316 L Stainless steel |
| B8 | AISI 309 Stainless steel |
| C2 | Aisi 416 Stainless steel, hardened |
| D1 | Polyvinylchloride (PVC) |
| D2 | Polypropylene (PP) |
| D2 | Molded polypropylene |
| D3 | Polyamide (PA) |
| D5 | Talcum filled Polypropylene |
| D6 | PP, 25% glassfibers |
| D7 | High density polyethylene |
| D8 | Polyvinylidene fluoride (PVDF) |
| E0 | EPDM |
| E1 | Polytetrafluorethylene (PTFE) |
| E2 | PTFE, 25% glassfibers |
| E3 | Acetalic resin (POM)/Delrin |
| E7 | Viton |
| E8 | Synthetic rubber (NBR) |
| G1 | Cast iron |
| H1 | Titanium Grade 2 |
| L1 | Monel 400 |
| L2 | Incolloy 825 |
| L6 | Hastelloy C22 |
| L8 | Hastelloy C276 |
| P6 | Acrylic but. styrene (ABS) |
| T1 | Brass |
| T2 | Brass, chrome plated |
| T3 | Copper |
| T5 | Bronze |
| T8 | Brass, nickel plated |
| T81 | Brass, electroless nickel plated |
| V1 | Aluminum |
| V7 | Aluminum, ENP |

Many of the products shown in this Catalogue are available in different materials, and therefore their identification code in the Catalog is not complete, the two last digits in the code used to specify the material being left indetermined as XX.

In such cases, please complete the code for your product with the final digits showing the required material as listed in the Catalog for every product. The coding for the most popular materials are listed in the following.

GENERAL INFORMATION

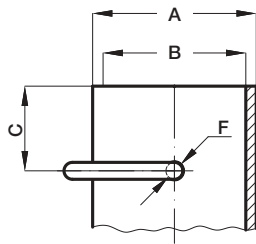

| | A | B | C | F |
|----------------------|------|------|------|-----|
| UBC Clip Euro | 29.0 | 25.3 | 15.0 | 3.2 |
| UBC Clip USA | 29.0 | 25.7 | 15.0 | 3.2 |
| UBD Clip Euro | 33.0 | 25.5 | 9.0 | 2.5 |
| UBD Clip USA | 33.0 | 25.7 | 9.0 | 2.5 |

CLIP - ON CONNECTION SIZES

There is a number of different dimensions standards relating to clip-on connections on different markets, and between Europe and the United States.

We have therefore identified with our Customers the most commonly requested types and have standardized as follows.

UAA spray balls

Clip dimensions are given directly into the performance tables.

UAC spray balls

This is the Pnr Standard for fixed spray balls and will later on be extended additional products.

This dimension standard is based on the European Pipe Nominal Diameter in mm.

Diagram and dimensions are shown at page 6 beside the capacity tables for UAC heads.

UBC and UBD types

For the two above product types clip-on connections will maintain specifications used until present time.

The diagram and the table showing the dimensions for the two product types an the different markets is shown below, and covers both European and American pipe dimensions.

TANK WASHING MANUAL

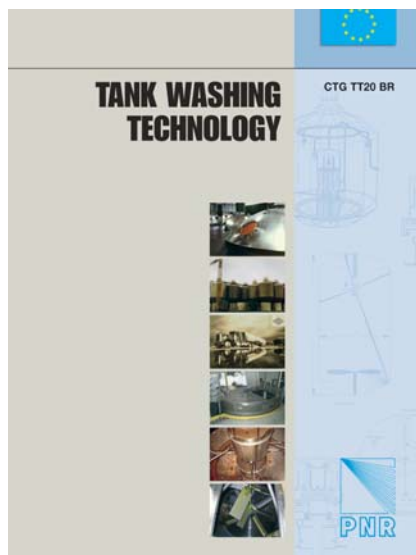

For our customers information we have published a very comprehensive manual showing the entire world of tank washing, to give a general view of the possibilities offered by the present technologies in this sector.

The manual can be requested to all PNR Companies and Distributors and is delivered at no cost.

GENERAL INFORMATION

ABBREVIATIONS

| | | | | | | | | |
|------------|-------------------------|---------|-----------|----------------|----|-----------|-----------------------------------|-----|
| A | SPRAY ANGLE | degrees | GM | WETTING RADIUS | m | LP | MAX WORKING TEMPERATURE | °C |
| D | DIAMETER | mm | H | HEIGHT | mm | LT | MAX WORKING PRESSURE | bar |
| D1 | DIAMETER | mm | H1 | HEIGHT | mm | NZ | STRAIGHT JET NOZZLE CAPACITY SIZE | -- |
| D2 | DIAMETER | mm | L | WIDTH | mm | PM | MINIMUM FREE PASSAGE | mm |
| Dia | NOZZLE ORIFICE DIAMETER | mm | L1 | WIDTH | mm | W | WEIGHT | kg |

PRODUCT WARRANTY

PNR products will be replaced or repaired at the option of PNR and free of charge if defective in manufacture, labeling or packaging. The above warranty conditions will apply if notice of defect is received by PNR within 30 days from date of product installation or one year from date of shipment. The cost of above said replacement or repair shall be the final solution for any breach of any warranty, and PNR shall not be held liable for any damages due to personal injuries or commercial losses caused by product malfunction.

OTHER PRODUCT RETURNS

Receiving returned products not precisely identified can originate delays in handling the single cases and even some product losses. In order to avoid such problems please follow the PNR procedures as described below.

PRODUCTS DELIVERED ERRONEOUSLY BY PNR

- 1 Obtain from PNR a RIN (Return ident number) and a DOC VRMI Form.
- 2 Return products to PNR including the DOC VRMI Form properly filled including RIN number.
- 3 PNR shall issue a Credit Note payable to you including product and all transport cost.

PRODUCTS ORDERED ERRONEOUSLY TO PNR

- 1 Returned products will only be accepted if in new original condition and properly packed.
- 2 Obtain from PNR a RIN (Return ident number) and a DOC VRMI Form.
- 3 Return products to PNR including the DOC VRMI Form properly filled including RIN number.
- 4 A 10% inspection and re-stocking charge and all transport cost are at charge of Customer.
- 5 A Credit note for the proper amount shall be issued and paid.

SPECIAL NON CATALOGUE PRODUCTS

The return of these products is only possible after PNR has issued an offer for purchase.

DISCLAIMER

Our products are manufactured with the best care and according to the latest developments of the technology, but we cannot assure that every one of our products is perfectly fit for any possible specific process. The information provided in this Catalogue is provided "as it is" and we make no warranty of any kind with respect to the subject matter or accuracy of the information contained herein. This publication may include technical inaccuracies or typographical errors and changes may be periodically made to the information herein without previous notice.

SENDING LIST

In order to automatically receive updates of our technical Documentation please photocopy this card and send it to us inside a sealed envelope, your details shall be kept on our Permanent Mailing List.

CTG SW20 BR

| | | | | | |
|----|----------|--------|--|--|--------------------------|
| 01 | COMPANY | | PNR PRODUCT RANGE | | PAPERMILL PRODUCTS |
| 02 | NAME | | GENERAL PURPOSE SPRAY NOZZLES | | STEELWORK NOZZLES |
| 03 | FUNCTION | | AIR ASSISTED ATOMIZERS | | SPRAYDRY NOZZLES |
| 04 | ADRESS | | COMPLEMENTARY PRODUCTS AND ASSEMBLY FITTINGS | | FIRE FIGHTING COMPONENTS |
| 05 | PHONE | FAX | TANK WASHING SYSTEMS | | |
| 06 | WEB SITE | E-MAIL | EVAPORATIVE COOLING SYSTEMS | | |

CTG LS20 BR

www.pnr-nozzles.com



Our products are distributed through:

PNR America
PNR Baltic
PNR Benelux
PNR China

PNR Czech Republic
PNR Deutschland
PNR France
PNR Italia

PNR Mexico
PNR Shanghai
PNR Taiwan
PNR U. Kingdom

We are moreover represented in:

Argentina
Australia
Austria
Brazil
Bulgaria
Canada
Chile
Denmark
Finland

Greece
India
Indonesia
Iran
Ireland
Japan
Korea
Norway
New Zealand

Pakistan
Poland
Portugal
Singapore
Spain
South Africa
Sweden
Turkey
Venezuela

